

*Made Right in the U.S.A.*

# **Installation and Service Manual**

**DM-6**  
**Digital Cinema Sound Adapter**

**SMART**

**THEATRE SYSTEMS**

5945 Peachtree Corners East  
Norcross, Georgia 30071

1 (800) 45-SMART or (404) 449-6698

# Digital Magic Model DM-6 Digital Sound Adapter



4 Thumb screws will allow the front panel to be removed. This is generally done only one time during installation.

The SMART Model DM-6 Digital Magic Digital Sound Controller is an interface unit designed to connect the audio outputs from digital signal processors such as the DTS or Dolby DA20 to an existing sound system. It does not matter what stereo processor you are now using. The outputs from your stereo processor are simply disconnected from the amplifier inputs and re-connected to the Optical Inputs on the DM-6. The DM-6 outputs are then connected to the amplifier inputs. The DM-6 will then pass either the optical signals or the signals

from the digital processor to the amplifiers. All switching is automatic, and there are manual as well as automatic fallbacks to the optical processor should the digital system or the DM-6 fail. The DM-6 has been made as failsafe as possible. Once the film is running, the operator does not have to do any switching except in certain types of failures.

Block diagram shows overall signal flow.

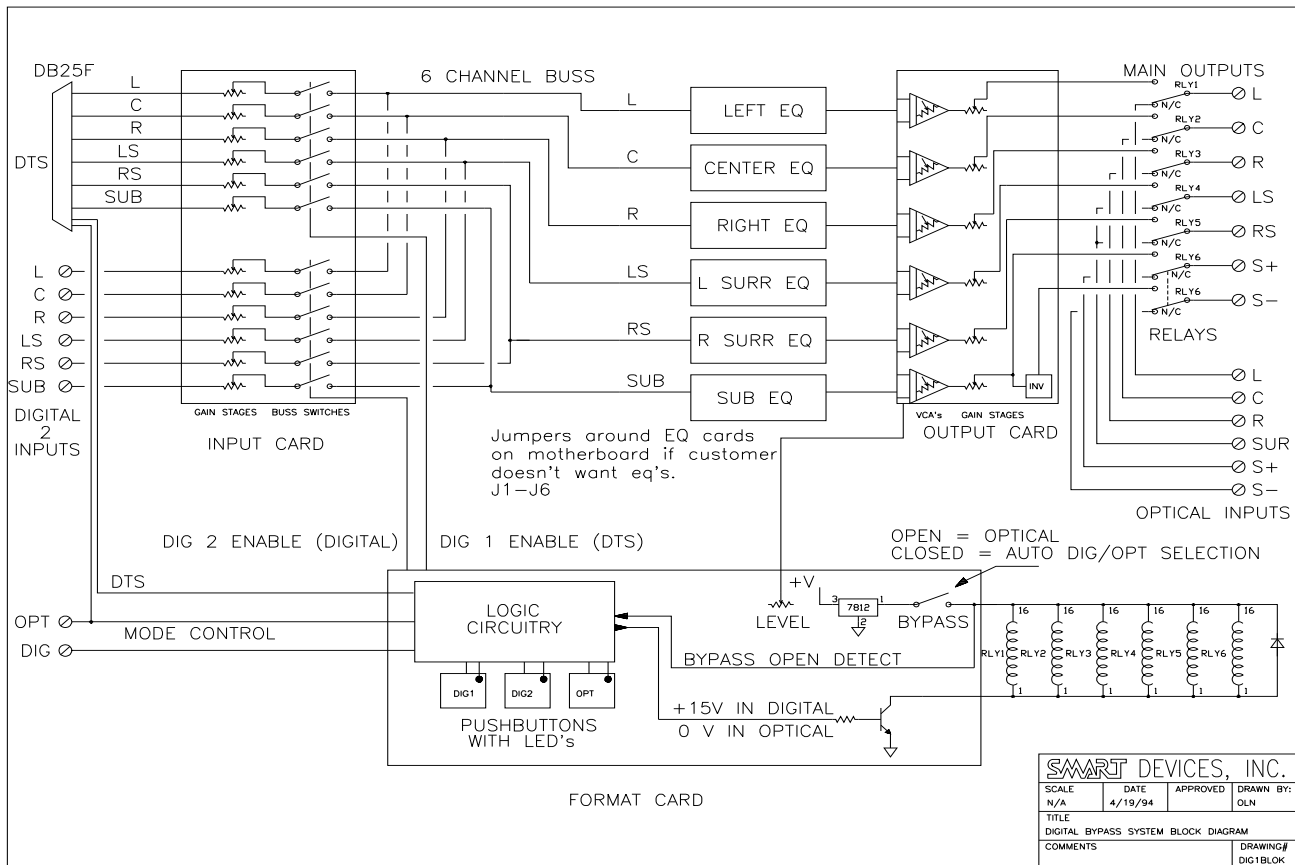

## Operation

Normally, there is no operator intervention required to use the DM-6 except to initially set the volume and to manually go to bypass during certain types of failures. The DM-6 is running under the command of the digital processor, and changes between digital mode and optical stereo are initiated by the digital processor. If the digital processor no longer sees a valid digital signal or timecode, then it will tell the DM-6 to go to Optical mode. If the digital processor or DM-6 fails but does NOT automatically go into optical mode, then the operator needs to push the optical button on the DM-6 front panel. If this still does not correct the problem, then the operator must throw the toggle switch on the DM-6 front panel to the bypass position. This will force the DM-6 into optical mode regardless of what the lighted pushbuttons are telling you.

## Installation

Locate the DM-6 close to the stereo processor and the digital processor. There are 3 cable sets which may be ordered with the DM6. One cable set is for connecting the DTS digital system to the DM6, and the other 2 are for the Dolby DA20. These cables are about 30 inches long, so keep this in mind when selecting a location. Also install any additional power amps if needed at this time (e.g., for split surrounds). The existing rack wiring harness may have to be extended or re-wired to accommodate the locations of the processors and to make new connections for any new amps. Install the power supply in the bottom of the rack and bring the power supply wiring harness up to the top left terminals

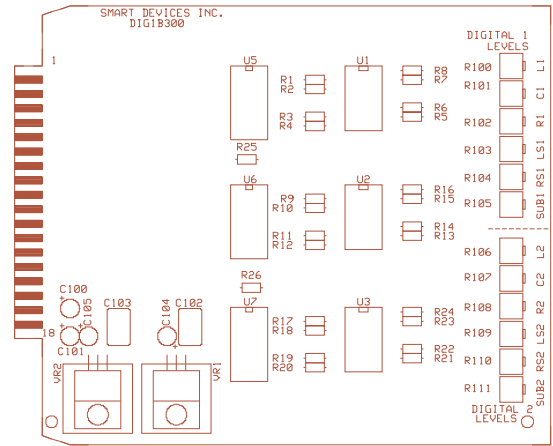

**The input card has two sets of input level controls for each of two digital sources. This allows you to match the levels between the players.**

on the DM-6. Please note that the Plus Voltage lead is red, the Minus Voltage lead is yellow, and the Ground lead is black. Do not connect the leads incorrectly as damage could result !

Disconnect the outputs from the stereo processor which go to the power amp inputs. These leads to the power amps will now connect to the output terminals of the DM-6. Add any new leads as needed for additional power amps.

Make a new wiring harness which will connect the outputs of the stereo processor to the OPTICAL INPUTS on the top left terminal strip on the rear of the DM-6. Please observe standard wiring practice, i.e., use 2 conductor + shield cable and ground the shield at one end only.

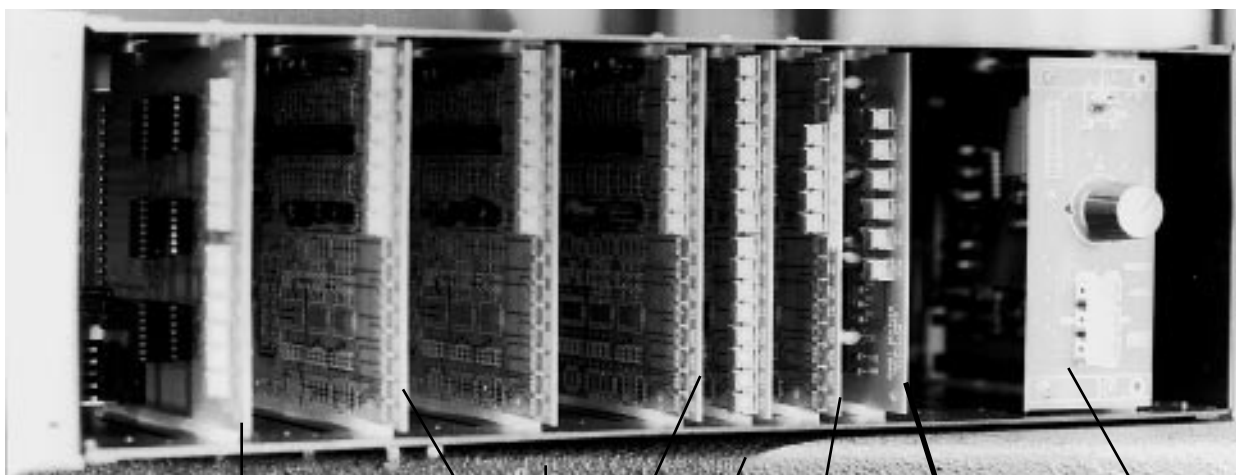

INPUT CARD

ONE OCTAVE EQ (3)

SUB BASS EQ

OUTPUT CARD

FORMAT CARD

DUAL ONE OCTAVE EQ FOR SURROUND CHANNELS

The first model of the DM-6 had one DB25 connector wired for the DTS system.

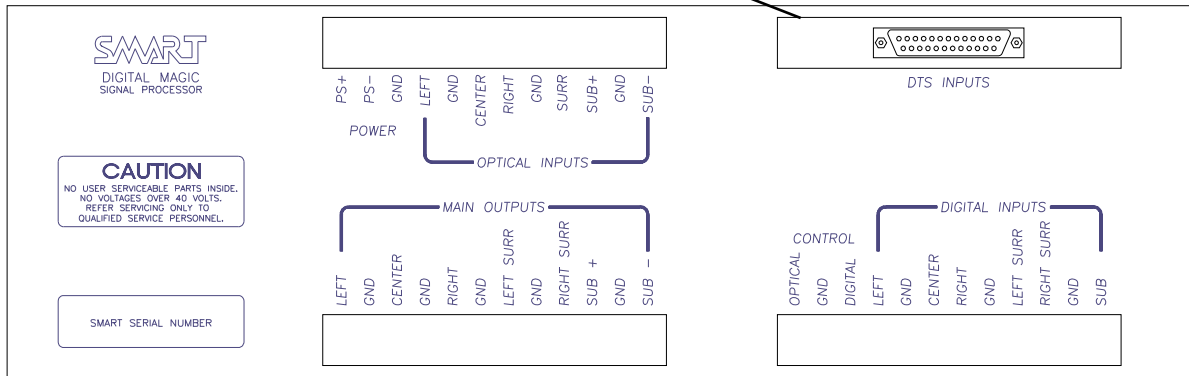

The first production run of the DM6 has one DB25 connector on the rear panel. This may be used for either the DTS or DA20 connection (with the appropriate cable) although the labeling on the front panel pushbuttons indicates this input as the DTS. The other digital input is labeled DIG on the front panel pushbuttons. If both DTS and DA20 processors are being used on the same DM6, the the DA20 will have to be wired to the input terminal strip on the DM6 while the DTS will plug into the DB25.

Now wire the digital processor outputs and control lines to the appropriate inputs on the rear of the DM-6. If you are using the DTS System and have ordered the DTS to DM-6 cable from SMART, it is only necessary to plug the cable in, and all connections are made for you. This cable, DM6-DTS, has a DB50 plug on one end which plugs into the mating connector on the DTS. The other end has a DB25 plug which plugs into the DB25 receptacle on the rear of the DM-6.

The second production run has an additional DB25 socket on the back of the p[roduct so that plugging in both the DTS and the DA20 simultaneously will be possible without having to wire directly to the terminal strips.

If you are wiring a Dolby DA20, connections will be made to either the DIGITAL INPUTS terminals on the bottom right terminal strip or to the DB25 connector on the rear of the DM-6. The 2 DA20 cable sets are configured as follows:

The current models have two DB25 connectors. One is wired for the DTS system and the other is for the Dolby DA20.

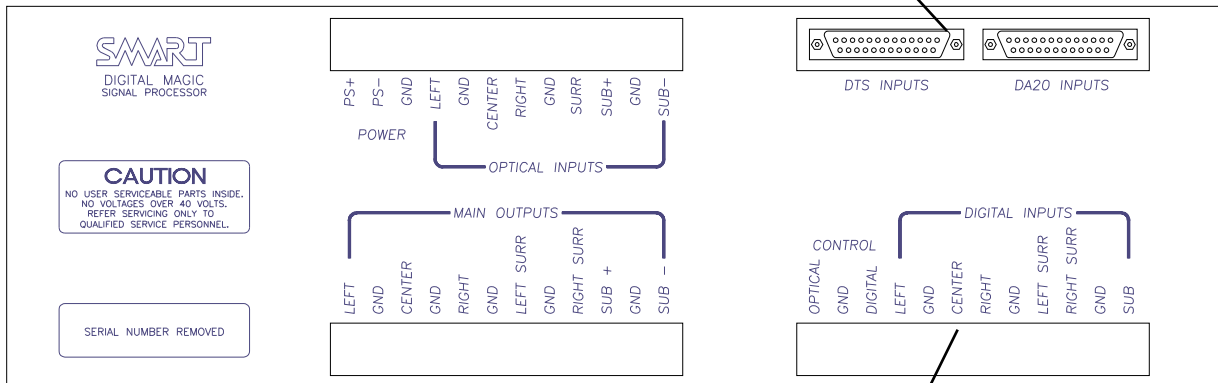

The DTS system is active when the front panel DTS button is lit. The Dolby DA20 is active when the DIGITAL light is lit. TRhe OPTICAL button may be pressed to return to the backup optical soundtrack when necessary.

Additional digital inputs are provided for other systems. The signals are connected to the individual terminals of the barrier strip. The DB25 for the DA20 is wired in parallel with the input terminal strips.

DM6-DA20/1 DB25 on DM6 end to 2 DB25 on DA20 end. This cable set allows easy plug-in operation. The 2 DB25's on the DA20 end plug into the Audio and Control connectors on the DA20.

DM6-DA20/2 Fanning strip for terminals on DM6 end to 2 DB25's on DA20 end. The 2 DB25's on the DA20 end plug into the Audio and Control connectors on the DA20.

Please refer to the DA 20 manual for other wiring considerations. In particular, the Motor Start connector must be jumpered from Pin 1 to Pin 5. This is explained in the DA20 Manual.

pins from the top of the Pink Noise Card on the component side. In this configuration, the surround switch on the Pink Noise Card will feed LS and RS simultaneously, so you will have to turn the LS Amplifier channel down while EQ'ing the the RS channel and vice versa.

Next, play the test disc or film and set the auditorium levels as recommended by the digital processor manufacturer. Please note that the DM-6 has several points in the signal path where the gain may be adjusted. However, it is suggested that you make all level adjustments on the digital processor itself, and only use the internal trimpots on the DM-6 if a normal level cannot be obtained.

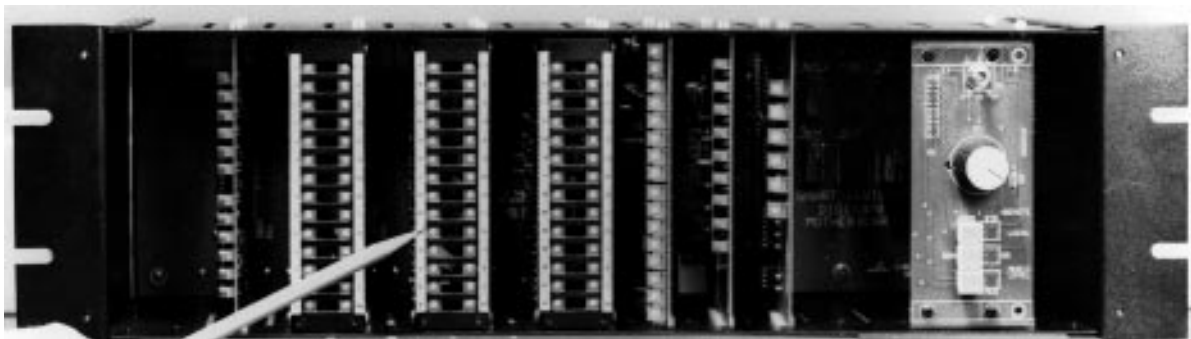

DM-6 shown with 1/3 octave stage channel equalizers

## Setup

It is necessary to feed pink noise at a 0.5 volt level into each digital input in order to properly set the EQ. Feed each channel and set the house EQ as you normally would for an optical stereo processor. The easiest place to inject the Pink Noise is at the Digital Inputs Terminal Strip on the rear of the DM6. If you have already made connections to the terminals, then just unplug the cable at the DTS or DA20. Now you can feed these inputs with no loading on your Pink Noise source. After EQ is done on all channels, just re-plug the connectors.

Alternatively, you can use your Smart Pink Noise Generator card plugged into the left end slot to set the EQ. First, remove the Input Switching Card, and then plug in the Pink Noise card. It is necessary to remove the Input card because if both were plugged in simultaneously, both cards would be fighting for control of the signal buss. Please note that the original Pink Noise card does not have LS and RS outputs. It is necessary to modify the pink noise card so that the one surround channel feeds LS and RS. Simply add a jumper wire from Pin 4 to Pin 5 on the Pink Noise Card. These are 4th and 5th

Please note that the DA20 Sub-Bass output is **10 dB lower** than the stage channels. The Sub-Bass channels on the DM6 Input Switching card have sufficient range to accommodate this lower level. The factory settings on the DM6 will already be set to compensate for this lower level on the second set of digital inputs. The factory settings on the DM6 for

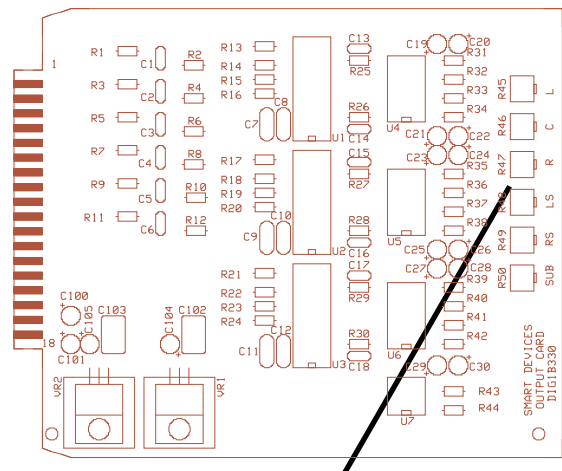

Trim pots on the OUTPUT CARD allow final level matching.

the first set of digital inputs will be set for DTS levels. If you hook a DA20 up to the first set of digital inputs (i.e., you are connecting to the first or only DB25 on the DM6), you will probably have to adjust the Sub-Bass level upward (using the Sub-Bass trimpot on the DM6 Input Switching Card) to accommodate the lower Sub-Bass level from the DA20.

If you must make adjustments to the factory settings on the DM-6, then use the trimpots on the INPUT SWITCHING card first. The top row of trimpots is for the DTS DB25 inputs, and the bottom row of trimpots is for the DIGITAL INPUTS terminals. If this still does not give proper levels, then use the OUTPUT card trimpots to get additional range of adjustment.

The optional sub bass equalizer card allows smoothing of the subwoofer system separately from the stage channel equalizers.

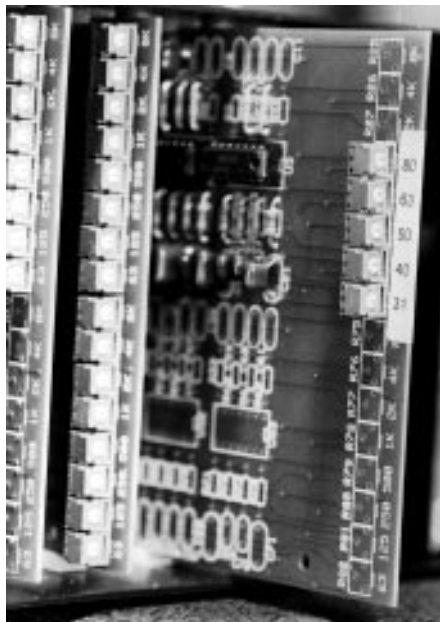

source to the DM-6 signal path. It also contains trimpots to adjust the signal levels if needed. These trimpots will not normally require re-adjustment from the factory settings except for the Sub-Bass level as mentioned in the SETUP section.

## Equalizer Card

The card shown is the full octave EQ card. Please note that only the top half of the card is used for the stage channels. Both top and bottom sections are used for the split surrounds. The top is Left Surround and the bottom is Right Surround. This same card is also used for the optional SubBass EQ, but fewer parts are installed. Optional 1/3 octave EQ cards may be installed for stage channels.

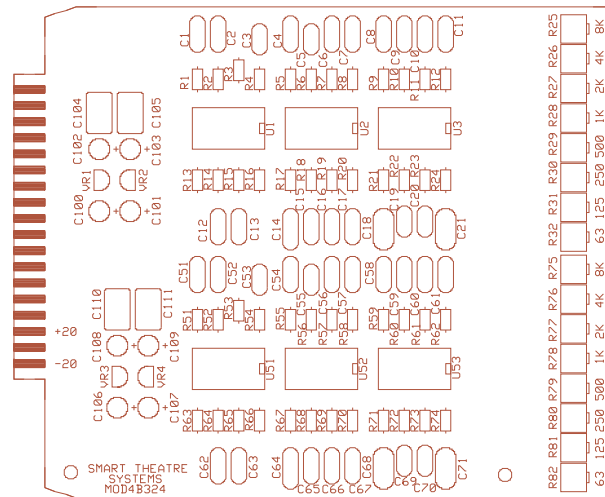

Dual one octave EQ card for split surround channels. Top set of pots is Left surround channel. Frequencies are printed on the edge of the card for each band.

## Output Card

This card contains the VCAs and output gain stages. The trimpots are used to vary the output signal levels which will feed the power amps. Do not adjust these unless the digital processor level controls will not give sufficient level. If necessary, set these while the test disk or film is running to achieve the film level recommended by the digital processor manufacturer.

## Input Switching Card

This card receives the six audio channels from the digital processors and switches the appropriate

Special factory made 3 foot cords are available for the DTS 6-channel system and the Dolby DA20 Digital. These cords have a pre-wired DB 25 on one end and fit the specific digital decoder on the other end. All control and audio signals are carried by the cord, and no additional wiring is required. These cords may be ordered by your SMART dealer. Cords may be extended, when extra length is required, by purchasing a standard computer cable with a DB25 on each end. Make sure the cord has all pins wired. Some computer cords do not.